

Pallet Cages, Trolleys & Collars

Type A Pallet Cage

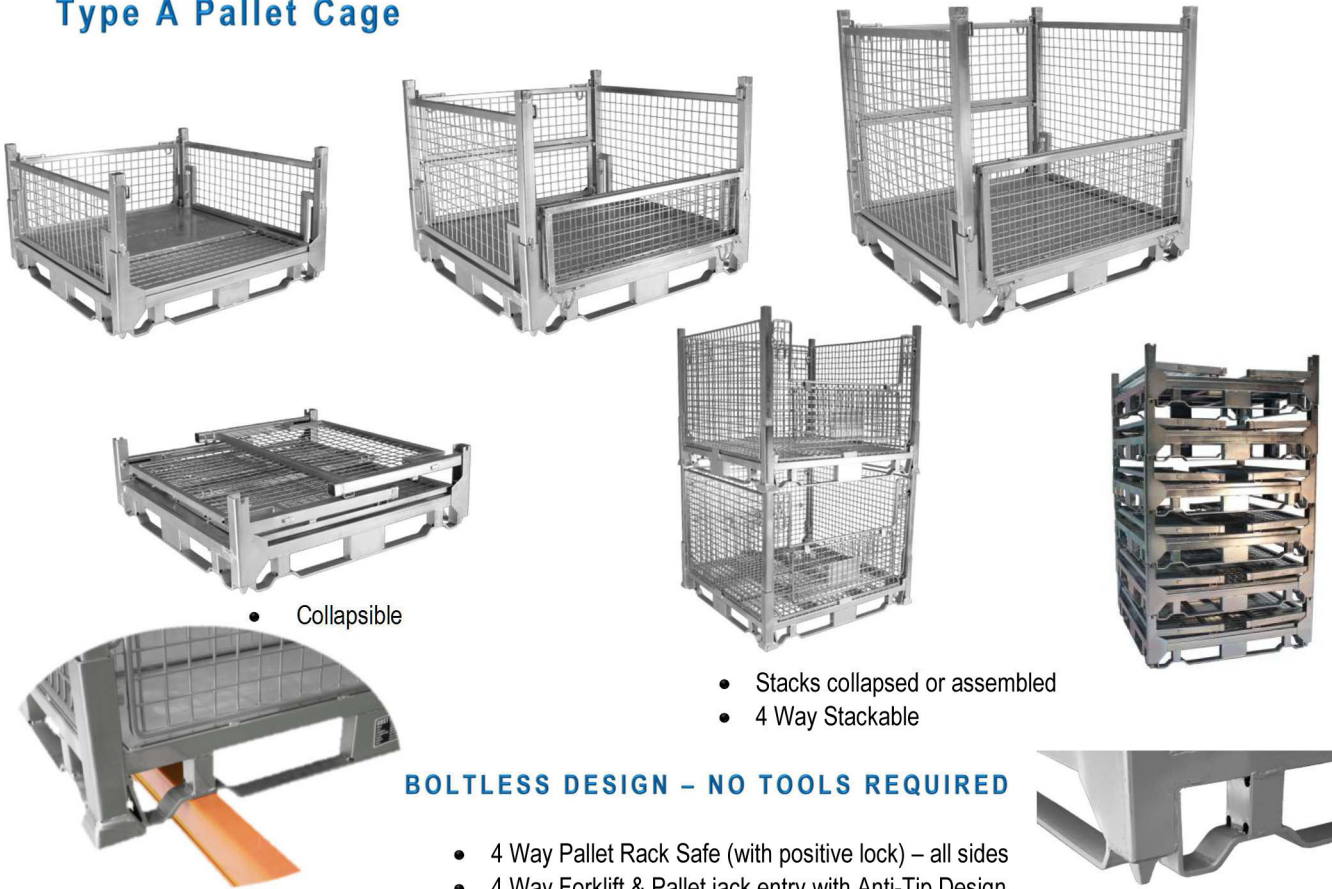

- Collapsible

- Stacks collapsed or assembled
- 4 Way Stackable

BOLTLESS DESIGN – NO TOOLS REQUIRED

- 4 Way Pallet Rack Safe (with positive lock) – all sides
- 4 Way Forklift & Pallet jack entry with Anti-Tip Design

- Spigot Feet

- Available in 3 heights – 650mm, 885mm & 1120mm
- Fully removable front & rear gates
- Half drop down front & rear gates fitted to the Medium & Large cages
- Mesh sides 50mm x 50mm x 3.5mm
- SWL – 1000KG (Uniformly distributed load)
- Zinc Plate Finish available with a Sheet or Mesh Floor
- Hot Dip Galv. Finish available with a Mesh Floor only – suitable for external use.

Type A Pallet Cage (Double width)





- Available in 2 heights – 650mm & 1120mm
- Fully removable front & rear gates
- Half drop down front & rear gates fitted to the Large Cage only.
- Mesh sides 50mm x 50mm x 3.5mm
- SWL – 650KG (Uniformly distributed load)
- Zinc Plate Finish available with a Sheet or Mesh Floor
- Hot Dip Galv. Finish available with a Mesh Floor only – suitable for external use.
- 2 Way Stackable , Stacks collapsed or assembled
- 2 Way Pallet Rack Safe (with positive lock) – 2 sides
- 2 Way Forklift & Pallet Jack Entry, with Anti-Tip Design.
- Spigot Feet.



Pallet Cages, Trolleys & Collars

Type A Pallet Cage (Specifications)

Product Code	Description	Dimensions WxDxH (mm)	Floor Type	Finish	
PC 500ZP	Type [A] Small	Internal – 1080 x 1080 x 400 External – 1160 x 1160 x 650 Collapsed height – 360 Weight – 94kg	Sheet Steel	Zinc Plated	
PC 530ZP	Type [A] Small	Internal – 1080 x 1080 x 400 External – 1160 x 1160 x 650 Collapsed height – 360 Weight – 93kg	Mesh	Zinc Plated	
PC 560HDG	Type [A] Small	Internal – 1080 x 1080 x 400 External – 1160 x 1160 x 650 Collapsed height – 360 Weight – 100kg	Mesh	Hot Dip Galvanised	

Product Code	Description	Dimensions WxDxH (mm)	Floor Type	Finish	
PC 505ZP	Type [A] Medium	Internal – 1080 x 1080 x 640 External – 1160 x 1160 x 885 Collapsed height – 360 Weight – 106kg	Sheet Steel	Zinc Plated	
PC 535ZP	Type [A] Medium	Internal – 1080 x 1080 x 640 External – 1160 x 1160 x 885 Collapsed height – 360 Weight – 104kg	Mesh	Zinc Plated	
PC 565HDG	Type [A] Medium	Internal – 1080 x 1080 x 640 External – 1160 x 1160 x 885 Collapsed height – 360 Weight – 111kg	Mesh	Hot Dip Galvanised	

Product Code	Description	Dimensions WxDxH (mm)	Floor Type	Finish	
PC 510ZP	Type [A] Large	Internal – 1080 x 1080 x 880 External – 1160 x 1160 x 1120 Collapsed height – 360 Weight – 117kg	Sheet Steel	Zinc Plated	
PC 540ZP	Type [A] Large	Internal – 1080 x 1080 x 880 External – 1160 x 1160 x 1120 Collapsed height – 360 Weight – 111kg	Mesh	Zinc Plated	
PC 570HDG	Type [A] Large	Internal – 1080 x 1080 x 880 External – 1160 x 1160 x 1120 Collapsed height – 360 Weight – 118kg	Mesh	Hot Dip Galvanised	



Pallet Cages, Trolleys & Collars

Specification cont-

Product Code	Description	Dimensions WxDxH (mm)	Floor Type	Finish	
PC 515ZP	Type [A] Small Double	Internal – 2110 x 1080 x 400 External – 2200 x 1160 x 650 Collapsed height – 360 Weight – 139kg	Sheet Steel	Zinc Plated	
PC 545ZP	Type [A] Small Double	Internal – 2110 x 1080 x 400 External – 2200 x 1160 x 650 Collapsed height – 360 Weight – 138kg	Mesh	Zinc Plated	
PC 575HDG	Type [A] Small Double	Internal – 2110 x 1080 x 400 External – 2200 x 1160 x 650 Collapsed height – 360 Weight – 136kg	Mesh	Hot Dip Galvanised	

Product Code	Description	Dimensions WxDxH (mm)	Floor Type	Finish	
PC 520ZP	Type [A] Large Double	Internal – 2110 x 1080 x 880 External – 2200 x 1160 x 1120 Collapsed height – 360 Weight – 170kg	Sheet Steel	Zinc Plated	
PC 550ZP	Type [A] Large Double	Internal – 2110 x 1080 x 880 External – 2200 x 1160 x 1120 Collapsed height – 360 Weight – 166kg	Mesh	Zinc Plated	
PC 580HDG	Type [A] Large Double	Internal – 2110 x 1080 x 880 External – 2200 x 1160 x 1120 Collapsed height – 360 Weight – 180kg	Mesh	Hot Dip Galvanised	



Pallet Cages, Trolleys & Collars

Type B Pallet Cage



**Dividable*

BOLTLESS DESIGN – NO TOOLS REQUIRED

- Collapsible



- Stacks collapsed or assembled
- 4 Way Stackable
- 4 Way Pallet Rack Safe (with positive lock) – all sides
- 4 Way Forklift & Pallet jack entry with Anti-Tip Design
- Available in 2 Heights 600mm & 920mm

- Fully removable front & rear gates
- Half drop down front gates
- Mesh sides 40mm x 40mm x 5mm
- SWL – 1000KG (Uniformly distributed load)
- Zinc Plate Finish available with a Sheet or Mesh Floor
- Hot Dip Galv. Finish available with a Mesh Floor only – suitable for external use.

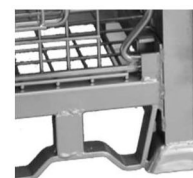



Cup Feet.

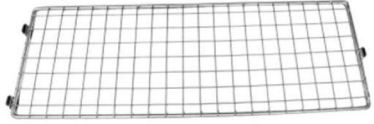

Pallet Cages, Trolleys & Collars

Type B Pallet Cage (Specifications)

Product Code	Description	Dimensions WxDxH (mm)	Floor Type	Finish	
PC 600ZP	Type [B] Small	Internal – 1070 x 1070 x 390 External – 1172 x 1172 x 600 Collapsed height – 330 Weight – 93kg	Sheet Steel	Zinc Plated	
PC 620ZP	Type [B] Small	Internal – 1070 x 1070 x 390 External – 1172 x 1172 x 600 Collapsed height – 330 Weight – 85kg	Mesh	Zinc Plated	
PC 640HDG	Type [B] Small	Internal – 1070 x 1070 x 390 External – 1172 x 1172 x 600 Collapsed height – 330 Weight – 89kg	Mesh	Hot Dip Galvanised	
PC 610ZP	Divider (Front to Back)	375mm High, (50x50mesh) Weight – 3kg * Small Cage Only	Zinc Plated		

Product Code	Description	Dimensions WxDxH (mm)	Floor Type	Finish	
PC 605ZP	Type [B] Large	Internal – 1070 x 1070 x 720 External – 1172 x 1172 x 920 Collapsed height – 330 Weight – 112kg	Sheet Steel	Zinc Plated	
PC 625ZP	Type [B] Large	Internal – 1070 x 1070 x 720 External – 1172 x 1172 x 920 Collapsed height – 330 Weight – 105kg	Mesh	Zinc Plated	
PC 645HDG	Type [B] Large	Internal – 1070 x 1070 x 720 External – 1172 x 1172 x 920 Collapsed height – 330 Weight – 110kg	Mesh	Hot Dip Galvanised	



Pallet Cages, Trolleys & Collars

Type C - Eco Pallet Cage



PC420 - 600mm High



- Flat pack
- 4 Way Stackable



BOLTLESS DESIGN – NO TOOLS REQUIRED

- 4 Way Pallet Rack Safe (with positive lock) – all sides
- 4 Way Forklift & Pallet jack entry with Anti-Tip Design
- Available in 2 heights – 600mm & 1000mm
- Fully removable front & rear gates
- Half drop down front
- Mesh sides 50mm x 50mm x 3.5mm
- SWL – 750KG (Uniformly distributed load)
- Zinc Plate Mesh Floor Finish

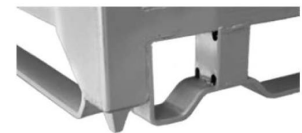



- Spigot Feet



PC430 -1000mm High

Eco Pallet Cage (Specifications)

Product Code	Description	Dimensions WxDxH (mm)	Floor Type	Finish	
PC 420ZP	Type [C] Small	Internal – 1080 x 1110 x 390 External – 1160 x 1160 x 600 Flat pack height – 300 Weight – 64kg	Mesh	Zinc Plated	
PC 430ZP	Type [C] Large	Internal – 1080 x 1110 x 810 External – 1160 x 1160 x 1000 Flat pack height – 300 Weight – 78kg	Mesh	Zinc Plated	



Pallet Cages, Trolleys & Collars

Pallet / Cage Trolleys

- To suit :
- Single Type Pallet Cages
- Australian Standard Hardwood Pallets
- Zinc Plated Finish
- Heavy Duty Swivel / Lockable wheels.
- SWL – 1000kg



Product Code	Description	Dimensions WxDxH (mm)	Finish	
PC 720ZP	Pallet / Cage Trolley	1175 x 1175 x 300 Weight – 51kg	Zinc Plated	

Mesh Pallet Collars

BOLTLESS DESIGN – NO TOOLS REQUIRED

- To suit :
- Australian Standard Hardwood Pallets
- Zinc Plated Finish
- Collapsible
- 400mm high - can be multi stacked to create additional height
- 50mm x 50mm x 3.5mm Mesh

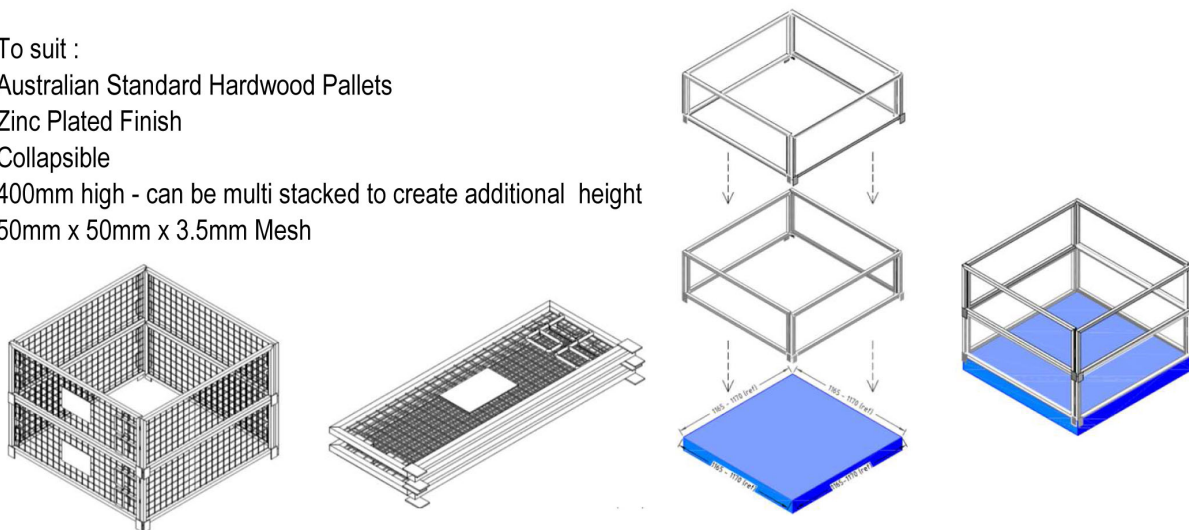

**Pallet not included*

Product Code	Description	Dimensions WxDxH (mm)	Finish	
PC 700ZP	Mesh Pallet Collar <i>*Pallet not included</i>	1170 x 1170 x 400 Collapsed – 1190 x 450 x 150 Weight – 25kg	Zinc Plated	